

# TLP572

PROGRAMMABLE CONTROLLERS  
 AC/DC-INPUT MODULE  
 SOLID STATE RELAY

The TOSHIBA TLP572 consists of a darlington connected photo-transistor optically coupled to a gallium arsenide infrared emitting diode in a six lead plastic DIP package.

TLP572 is no-base internal connection for high-EMI environments.

- Collector-Emitter Voltage : 55V (Min.)
- Current Transfer Ratio : 1000% (Min.)
- Isolation Voltage : 2500Vrms (Min.)
- UL Recognized : UL1577, File No. E67349

Unit in mm

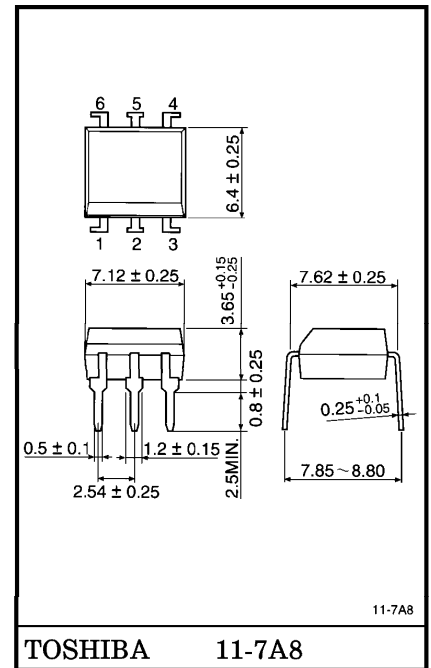

PIN CONFIGURATIONS (TOP VIEW)

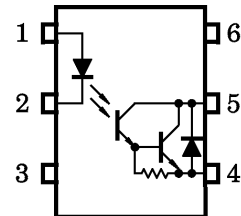

- 1 : ANODE
- 2 : CATHODE
- 3 : NC
- 4 : EMITTER
- 5 : COLLECTOR
- 6 : NC

## MAXIMUM RATINGS (Ta = 25°C)

CHARACTERISTIC		SYMBOL	RATING	UNIT
LED	Forward Current	I <sub>F</sub>	50	mA
	Forward Current Derating (Ta ≥ 53°C)	I <sub>F</sub> /°C	-0.7	mA/°C
	Peak Forward Current (100μs pulse, 100pps)	I <sub>FP</sub>	1	A
	Reverse Voltage	V <sub>R</sub>	5	V
	Junction Temperature	T <sub>j</sub>	125	°C
DETECTOR	Collector-Emitter Voltage	V <sub>CEO</sub>	55	V
	Emitter-Collector Voltage	V <sub>ECO</sub>	0.3	V
	Collector Current	I <sub>C</sub>	150 / -10	mA
	Power Dissipation	P <sub>C</sub>	150	mW
	Power Dissipation Derating (Ta ≥ 25°C)	P <sub>C</sub> /°C	-1.5	mW/°C
	Junction Temperature	T <sub>j</sub>	125	°C
Storage Temperature Range		T <sub>stg</sub>	-55~125	°C
Operating Temperature Range		T <sub>opr</sub>	-30~85	°C
Lead Soldering Temperature (10s)		T <sub>sol</sub>	260	°C
Total Package Power Dissipation		P <sub>T</sub>	200	mW
Total Package Power Dissipation Derating (Ta ≥ 25°C)		P <sub>D</sub> /°C	-2.6	mW/°C
Isolation Voltage (AC, 1min., R.H. ≤ 60%) (Note 1)		BV <sub>S</sub>	2500	V <sub>rms</sub>

(Note 1) Device considered a two terminal device : Pins 1, 2 and 3 shorted together and pins 4, 5 and 6 shorted together.

## RECOMMEND OPERATING CONDITIONS

CHARACTERISTIC	SYMBOL	MIN.	TYP.	MAX.	UNIT
Supply Voltage	V <sub>CC</sub>	—	12	24	V
Forward Current	I <sub>F</sub>	—	—	25	mA
Collector Current	I <sub>C</sub>	—	—	40	mA
Operating Temperature	T <sub>opr</sub>	-30	—	85	°C

INDIVIDUAL ELECTRICAL CHARACTERISTICS (Ta = 25°C)

CHARACTERISTIC		SYMBOL	TEST CONDITION	MIN.	TYP.	MAX.	UNIT
LED	Forward Voltage	$V_F$	$I_F = 10\text{mA}$	1.0	1.15	1.3	V
	Reverse Current	$I_R$	$V_R = 5\text{V}$	—	—	10	$\mu\text{A}$
	Capacitance	$C_T$	$V = 0, f = 1\text{MHz}$	—	30	—	pF
DETECTOR	Collector-Emitter Breakdown Voltage	$V_{(BR)CEO}$	$I_C = 1\text{mA}$	55	—	—	V
	Emitter-Collector Breakdown Voltage	$V_{(BR)ECO}$	$I_E = 0.1\text{mA}$	0.3	—	—	V
	Collector Dark Current	$I_{CEO}$	$V_{CE} = 24\text{V}$	—	10	200	nA
			$V_{CE} = 24\text{V}, T_a = 85^\circ\text{C}$	—	0.5	10	$\mu\text{A}$
Capacitance (Collector to Emitter)	$C_{CE}$	$V = 0, f = 1\text{MHz}$	—	10	—	pF	

COUPLED ELECTRICAL CHARACTERISTICS (Ta = 25°C)

CHARACTERISTIC	SYMBOL	TEST CONDITION	MIN.	TYP.	MAX.	UNIT
Current Transfer Ratio	$I_C / I_F$	$I_F = 1\text{mA}, V_{CE} = 1.2\text{V}$	1000	2000	—	%
Collector-Emitter Saturation Voltage	$V_{CE(sat)}$	$I_C = 100\text{mA}, I_F = 10\text{mA}$	0.3	—	1.2	V

ISOLATION CHARACTERISTICS (Ta = 25°C)

CHARACTERISTIC	SYMBOL	TEST CONDITION	MIN.	TYP.	MAX.	UNIT
Capacitance (Input to Output)	$C_S$	$V_S = 0, f = 1\text{MHz}$	—	0.8	—	pF
Isolation Resistance	$R_S$	$V_S = 500\text{V}, R.H. \leq 60\%$	$5 \times 10^{10}$	$10^{14}$	—	$\Omega$
AC Isolation Voltage	$BV_S$	AC, 1 minute	2500	—	—	$V_{rms}$

SWITCHING CHARACTERISTICS (Ta = 25°C)

CHARACTERISTIC	SYMBOL	TEST CONDITION	MIN.	TYP.	MAX.	UNIT
Rise Time	$t_r$	$V_{CC} = 10V, I_C = 10mA$ $R_L = 100\Omega$	—	—	—	$\mu S$
Fall Time	$t_f$		—	—	—	
Turn-on Time	$t_{on}$		—	—	—	
Turn-off Time	$t_{off}$		—	—	—	
Turn-on Time	$t_{ON}$	$R_L = 180\Omega$ (Fig.1) $V_{CC} = 10V, I_F = 10mA$	—	3	—	$\mu S$
Storage Time	$t_s$		—	—	—	
Turn-off Time	$t_{OFF}$		—	30	—	

Fig.1 SWITCHING TIME TEST CIRCUIT

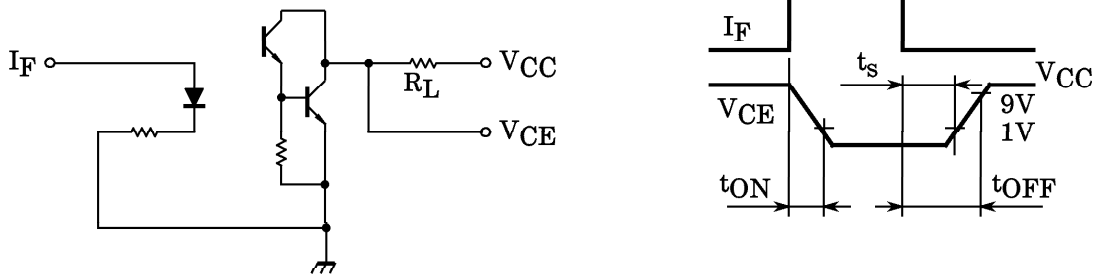

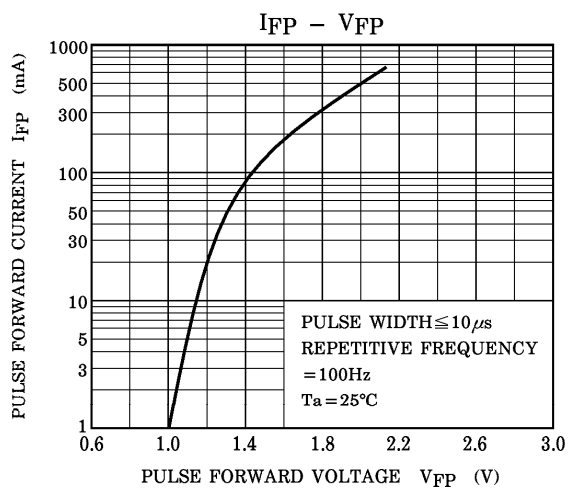
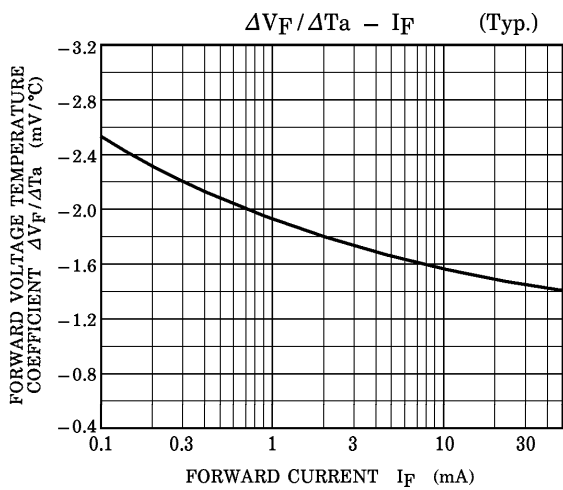
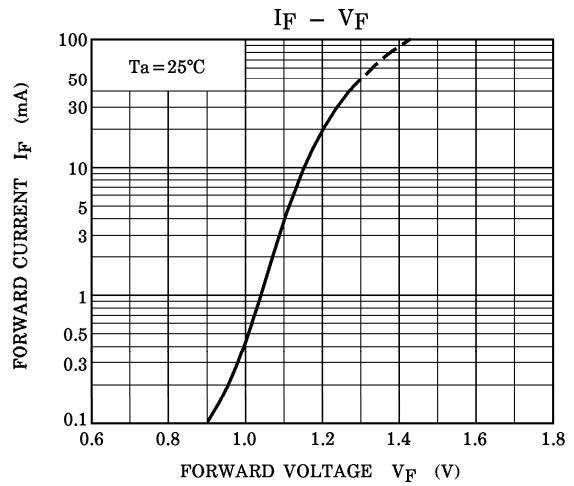
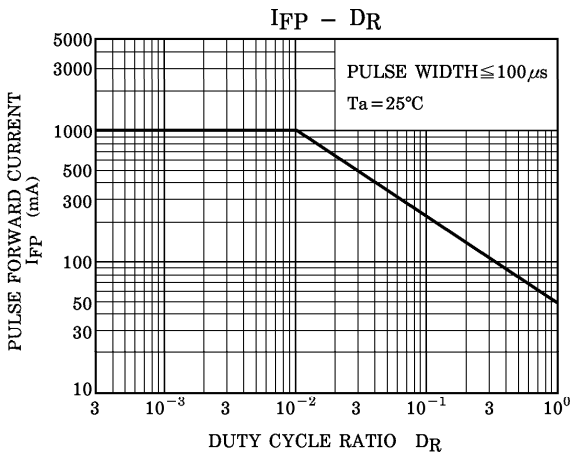
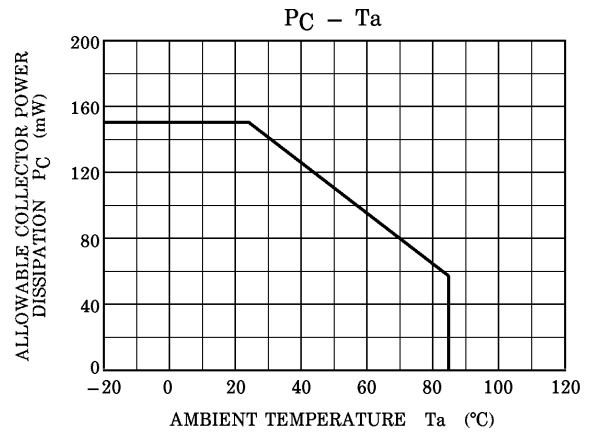
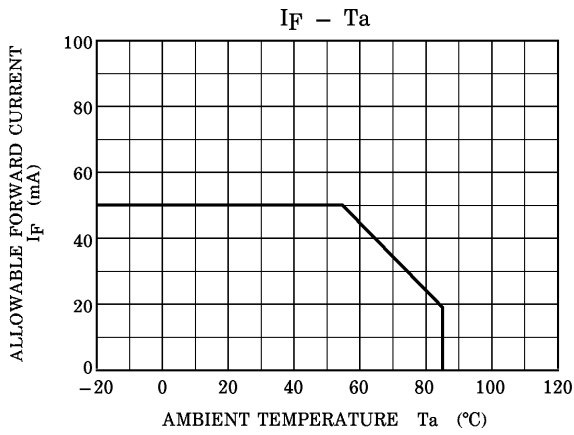

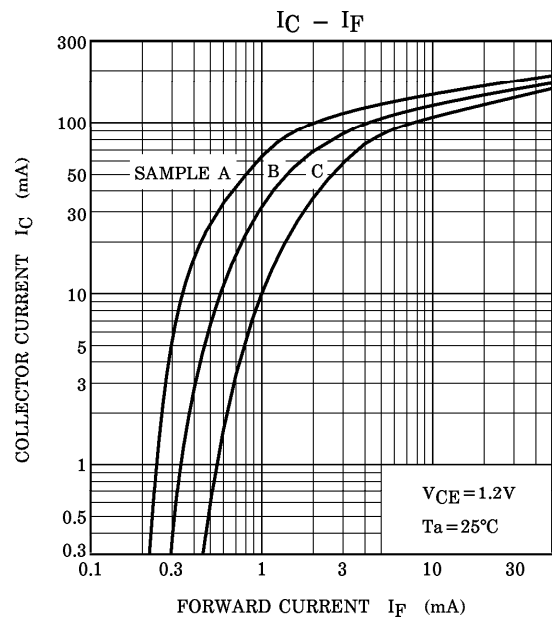
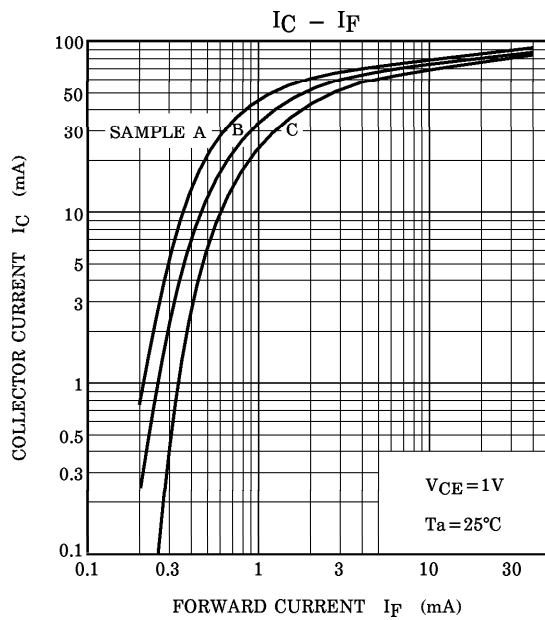
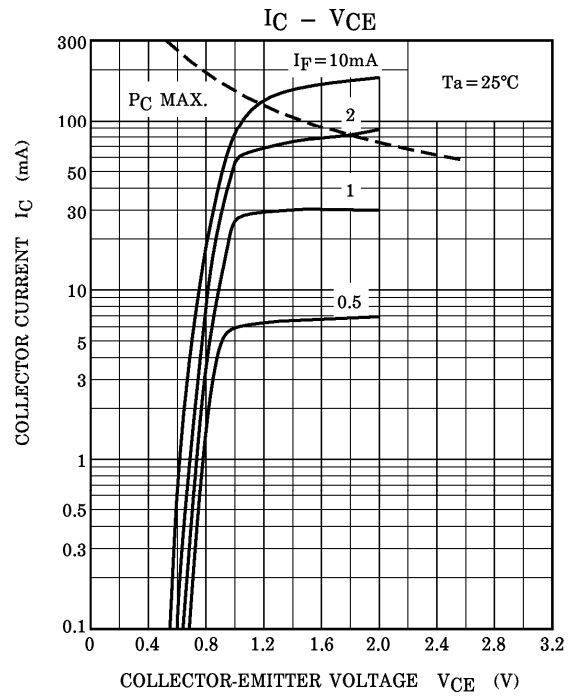
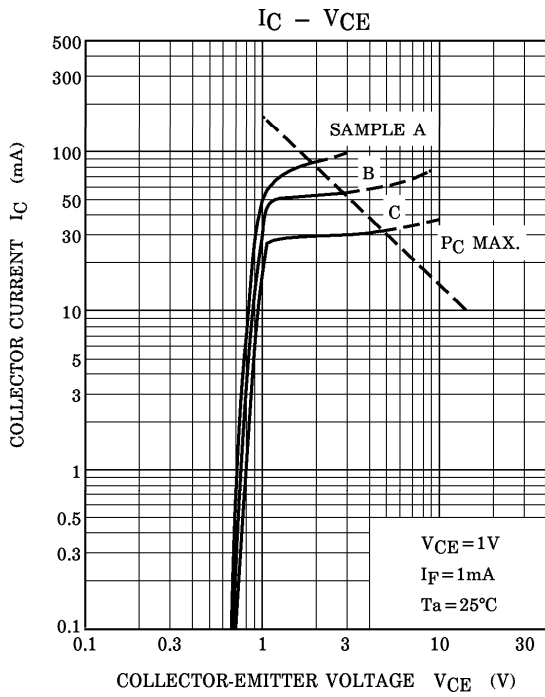

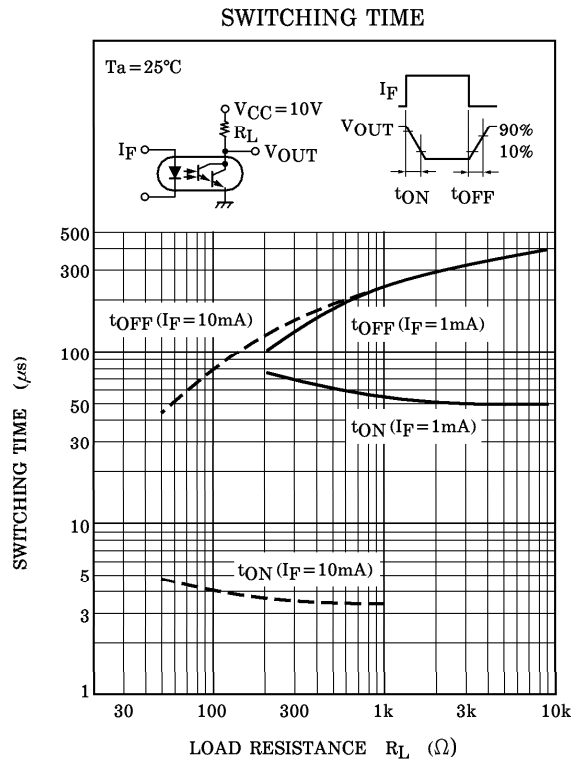
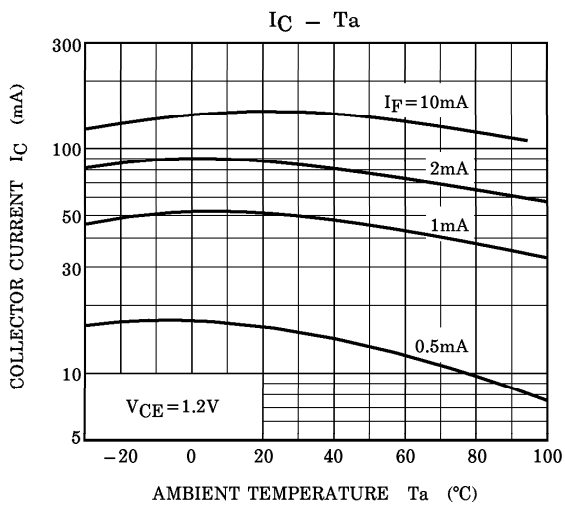
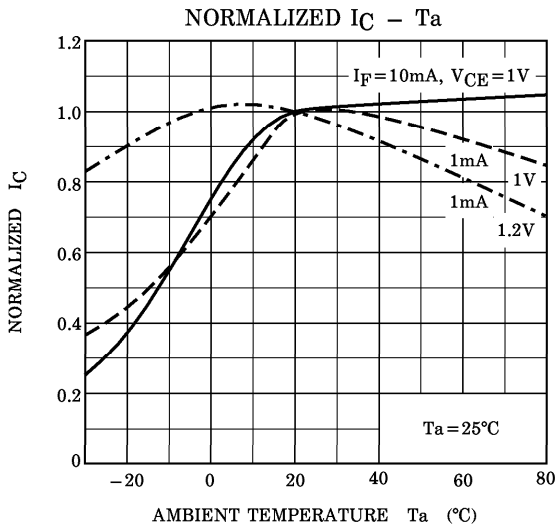

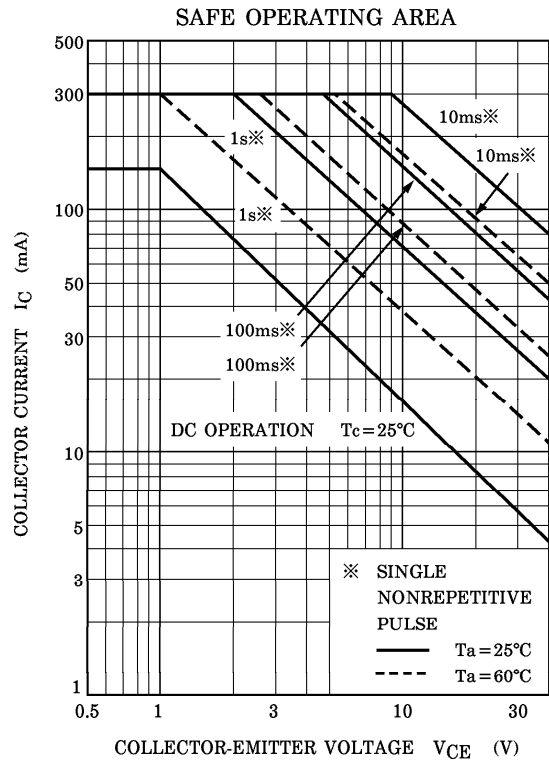
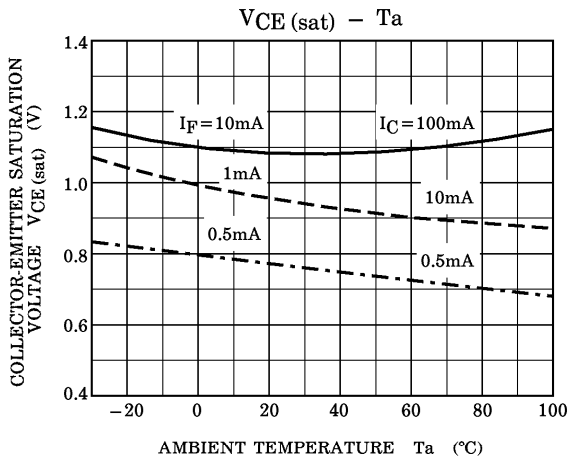



**RESTRICTIONS ON PRODUCT USE**

000707EBC

- TOSHIBA is continually working to improve the quality and reliability of its products. Nevertheless, semiconductor devices in general can malfunction or fail due to their inherent electrical sensitivity and vulnerability to physical stress. It is the responsibility of the buyer, when utilizing TOSHIBA products, to comply with the standards of safety in making a safe design for the entire system, and to avoid situations in which a malfunction or failure of such TOSHIBA products could cause loss of human life, bodily injury or damage to property. In developing your designs, please ensure that TOSHIBA products are used within specified operating ranges as set forth in the most recent TOSHIBA products specifications. Also, please keep in mind the precautions and conditions set forth in the "Handling Guide for Semiconductor Devices," or "TOSHIBA Semiconductor Reliability Handbook" etc..
- The TOSHIBA products listed in this document are intended for usage in general electronics applications (computer, personal equipment, office equipment, measuring equipment, industrial robotics, domestic appliances, etc.). These TOSHIBA products are neither intended nor warranted for usage in equipment that requires extraordinarily high quality and/or reliability or a malfunction or failure of which may cause loss of human life or bodily injury ("Unintended Usage"). Unintended Usage include atomic energy control instruments, airplane or spaceship instruments, transportation instruments, traffic signal instruments, combustion control instruments, medical instruments, all types of safety devices, etc.. Unintended Usage of TOSHIBA products listed in this document shall be made at the customer's own risk.
- Gallium arsenide (GaAs) is a substance used in the products described in this document. GaAs dust and fumes are toxic. Do not break, cut or pulverize the product, or use chemicals to dissolve them. When disposing of the products, follow the appropriate regulations. Do not dispose of the products with other industrial waste or with domestic garbage.
- The products described in this document are subject to the foreign exchange and foreign trade laws.
- The information contained herein is presented only as a guide for the applications of our products. No responsibility is assumed by TOSHIBA CORPORATION for any infringements of intellectual property or other rights of the third parties which may result from its use. No license is granted by implication or otherwise under any intellectual property or other rights of TOSHIBA CORPORATION or others.
- The information contained herein is subject to change without notice.

Copyright Each Manufacturing Company.

All Datasheets cannot be modified without permission.

This datasheet has been download from :

[www.AllDataSheet.com](http://www.AllDataSheet.com)

100% Free DataSheet Search Site.

Free Download.

No Register.

Fast Search System.

[www.AllDataSheet.com](http://www.AllDataSheet.com)